

Corner Brackets / Corner Blind Brackets

For 6 Series (Slot Width 8mm) Aluminum Extrusions 30 Square

■ Features: A bracket can connect extrusions in 2 and 3-ways, including function as extrusion end caps.

Corner Bracket Set

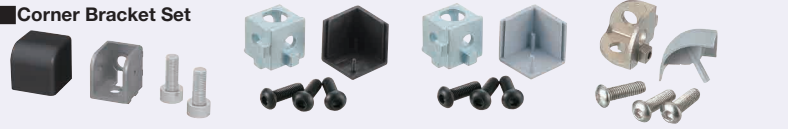

Type	Material	Surface Treatment
HBLCS6	①ADC12 ②Polyamide	-
HBLCR6	①ZDC2 ②Polyamide	Trivalent Chromate
HBLCD6	①SCS13 ②Polyamide	-

Two-Way Type HBLCS6-B

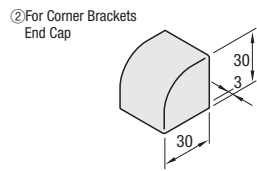
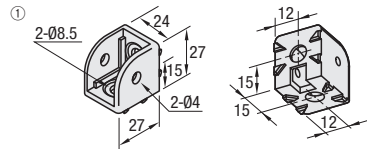

② For Corner Brackets End Cap

Three-Way Type HBLCR6-B (Cap: Black) HBLCR6-S (Cap: Gray)

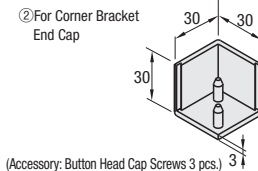
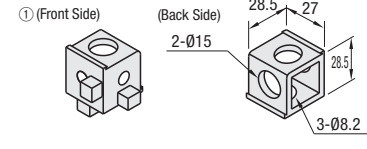

② For Corner Bracket End Cap

(Accessory: Button Head Cap Screws 3 pcs.)
* As HBLCR6-□ is zinc die cast, use it under 100°C.

HBLCD6-S (Cap: Gray)

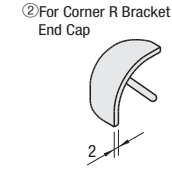
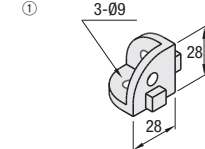

② For Corner R Bracket End Cap

(Accessory: Button Head Cap Screws 3 pcs.)

Part Number	Mass (g)	Included Screw		Allowable Load (N)	Unit Price (1-99 pc(s))	Volume Discount Rate (100-120)
		Screw	Quantity			
HBLCS6-B	27	CBS8-25	2	500		
HBLCR6-B	59	BCB8-25	3	999		
HBLCR6-S						
HBLCD6-S	45	Button Head Cap Screw M6x25	3	1862		

Part Number	Material	Surface Treatment
HBLCR6-B	ADC12	-

Example

App. Example: Corner Bracket HBLCR6

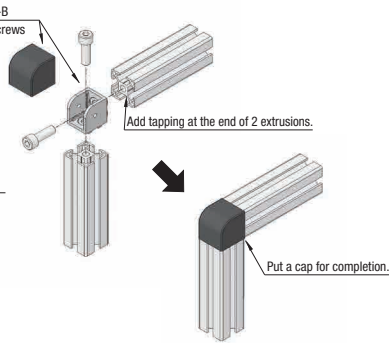
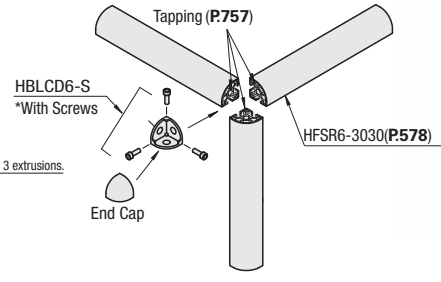
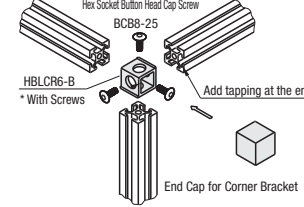

■ Features: Brackets for internal connection without alterations, including function as extrusion end caps.

Corner Blind Brackets



Type	Material	Surface Treatment
HBLBCA6	S45C	Trivalent Chromate
SHBLBCA6	SCS13	-

Two-Way Type

HBLBCA6 SHBLBCA6

(Stainless Steel)

Applicable to 3030 Square only.

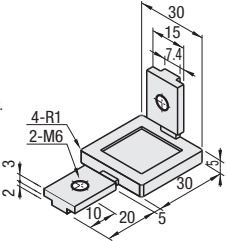

Three-Way Type

HBLBCB6 SHBLBCB6

(Stainless Steel)

Applicable to 3030 Square only.

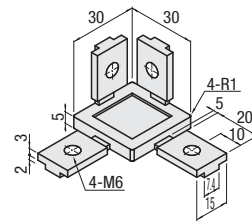

Part Number	Mass (g)	Included Screw		Allowable Load (N)	Unit Price (1-99 pc(s))	Volume Discount Rate (100-150)
		Screw	Quantity			
HBLBCA6	53	Set Screw M6x8	2	500		
SHBLBCA6						
HBLBCB6	71	Set Screw M6x8	4	1000		
SHBLBCB6						

Example

App. Example: Corner Blind Bracket

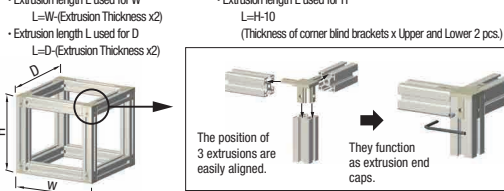

Ordering Example Part Number SHBLBCA6

Blind Brackets

For 6 Series (Slot Width 8mm) Aluminum Extrusions

■ Features: No need for alterations to hide brackets inside of the slot.

Blind Brackets

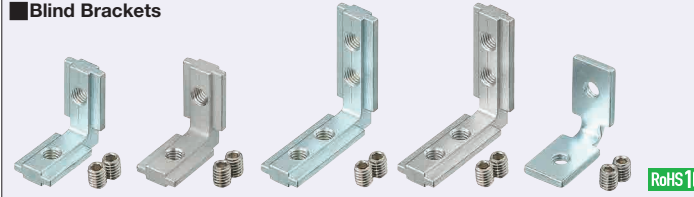

Type	Material	Surface Treatment
HBLBS6	S45C	Trivalent Chromate
SHBLBS6	SCS13	-
HBLBSL6	SCS13	-
SHBLBSL6	SCS13	-
HBLPBS6	SPCC	Trivalent Chromate

Blind Brackets

HBLBS6 SHBLBS6

(Stainless Steel)

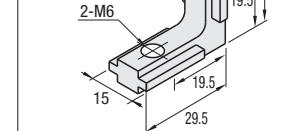

Sheet Metal Blind Brackets

HBLPBS6

(Stainless Steel)

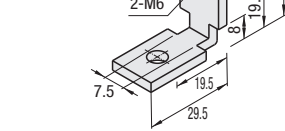

Blind Brackets - Long Type

HBLBSL6 SHBLBSL6

(Stainless Steel)

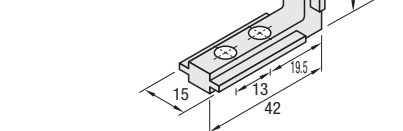

Part Number	Mass (g)	Included Screw		Allowable Load (N)	Unit Price (1-99 pc(s))	Volume Discount Rate (100-120)
		Screw	Quantity			
HBLBS6	30	Set Screw M6x8	2	686		
SHBLBS6						
HBLBSL6	38		4	957		
SHBLBSL6						
HBLPBS6	16		2	500		

Example

How to Use: Blind Brackets

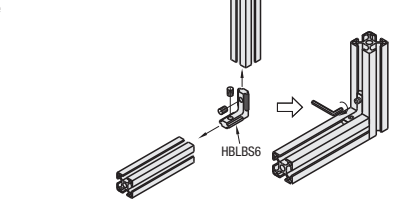

■ Features: Post-Assembly Insertion Type for Blind Brackets.

Post-Assembly Insertion Blind Brackets



Type	Components	Material	Surface Treatment
HABLBS6	Post-Assembly Insertion BB Body Post-Assembly Insertion BB Nut Set Screw	SCS13 SUS304 Sintered Alloy SUS304	-

HABLBS6

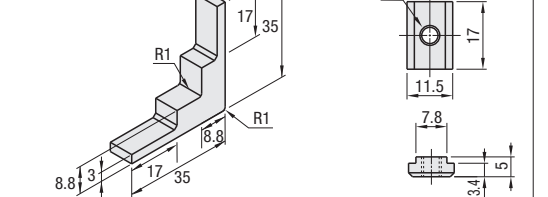

Part Number	Mass (g)	Included Screw		Allowable Load (N)	Unit Price (1-99 pc(s))	Volume Discount Rate (100-120)
		Screw	Quantity			
HABLBS6	28	Nut, Set Screw M6x5	2	500		

Example

How to Use Post-Assembly Insertion Blind Brackets

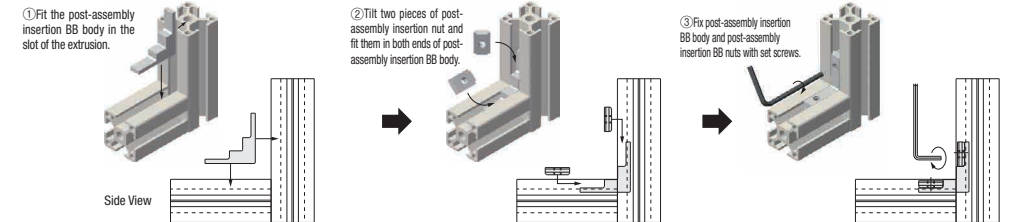

■ Features: Blind Brackets to connect 30, 20 square Extrusions.

Blind Brackets for Different Extrusion Sizes



Type	Material	Surface Treatment
HBLBS6-5	S45C	Trivalent Chromate

HBLBS6-5

(For 30 Square - 20 Square Connection)

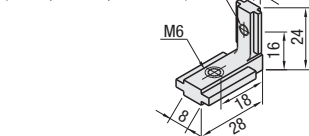

Part Number	Mass (g)	Extrusion Series	Included Screw		Unit Price (1-99 pc(s))	Volume Discount Rate (100-120)
			Screw	Quantity		
HBLBS6-5	20	HFS6 and HFS5	Set Screw M4x5 Set Screw M6x8	1 1		

Ordering Example

Part Number HBLBS6