

Double-Sided Melamine Resin Glued Laminated Plywood / Laminated Plywood

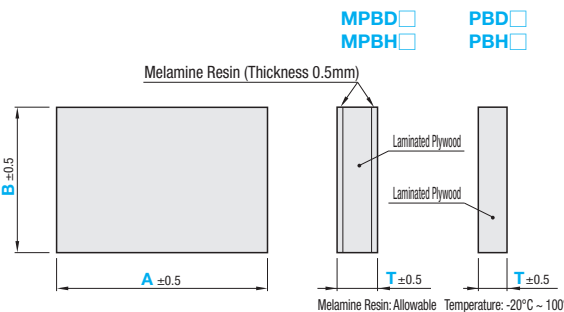

MPBD (Glued Melamine Resin) **PBD** (Laminated Plywood)
MPBH (Glued Melamine Resin) **PBH** (Laminated Plywood)

Melamine Resin (Thickness 0.5mm)



Type **Material**
MPBD Laminated Plywood (Poplar)
MPBH Double-Sided Melamine Resin
PBD Laminated Plywood (Poplar)
PBH Laminated Plywood (Poplar)

Melamine Resin: Allowable Temperature: -20°C ~ 100°C

MPBD
PBD

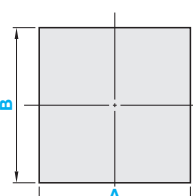

MPBDA
PBDA

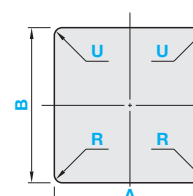

MPBDB
PBDB

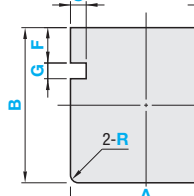

MPBDC
PBDC

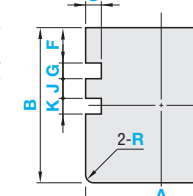

MPBH
PBH

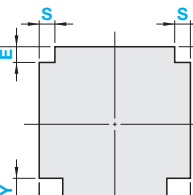

MPBHA
PBHA

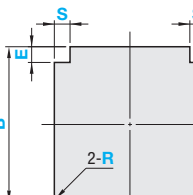

MPBHB
PBHB

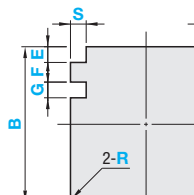

MPBHC
PBHC

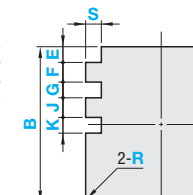

Ⓜ The shapes of notched angle are as shown on the left-side figure.

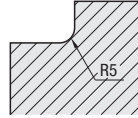
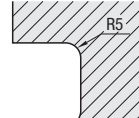
Part Number		A	B	Color	R U Selection	E	G	K	S	X	Y	F	J		
Type	T Selection	1mm Increment	1mm Increment			15-60 1mm Increment				1mm Increment					
MPBD	10 15 20	200~1200	200~1000	S (Gray)	-	-	-	-	-	-	-	-	-		
MPBDA					0	-	-	-	-	-	-	-	-	-	-
MPBDB					10	-	G	-	S	-	-	-	-	F	-
MPBDC					20	-	G	K	S	-	-	-	-	F	J
MPBHA					0	E	-	-	S	X	Y	-	-	-	-
MPBHB					10	E	G	-	S	-	-	-	-	F	-
MPBHC					20	E	G	K	S	-	-	-	-	F	J
PBD					-	-	-	-	-	-	-	-	-	-	-
PBDA	12 16 20	200~1200	200~1000	-	0	-	-	-	-	-	-	-	-		
PBDB					10	-	G	-	S	-	-	-	-	F	-
PBDC					20	-	G	K	S	-	-	-	-	F	J
PBH					0	E	-	-	S	X	Y	-	-	-	-
PBHA					10	E	-	-	S	-	-	-	-	-	-
PBHB					20	E	G	-	S	-	-	-	-	F	-
PBHC					30	E	G	K	S	-	-	-	-	F	J
PBD					-	-	-	-	-	-	-	-	-	-	-

 **Ordering Example** **Part Number** - **A** - **B** - **Color** - **R** - **U** - **E, G, K, S, X, Y, F, J**
MPBHB20 - 800 - 600 - S - R20 - E30 - G30 - S30 - F60
PBD12 - 320 - 250

Part Number	A Selection	Unit Price			
		B			
Type	T	200~400	401~600	601~800	801~1000
<Base Plate> MPBD MPBDA MPBDB MPBDC MPBH MPBHA MPBHB MPBHC (Melamine Resin Laminated Plywood)	10	200~ 400			
		401~ 600			
		601~ 800			
		801~1000			
	15	200~ 400			
		401~ 600			
		601~ 800			
		801~1000			
20	200~ 400				
	401~ 600				
	601~ 800				
	801~1000				

Part Number	A Selection	Unit Price			
		B			
Type	T	200~400	401~600	601~800	801~1000
<Base Plate> PBD PBDA PBDB PBDC PBH PBHA PBHB PBHC (Laminated Plywood)	12	200~ 400			
		401~ 600			
		601~ 800			
		801~1000			
	16	200~ 400			
		401~ 600			
		601~ 800			
		801~1000			
20	200~ 400				
	401~ 600				
	601~ 800				
	801~1000				

Notching Charge
Applicable Codes Unit Price/2 Places (Right and Left)
 (Notching) **E G K Y**
 (Corner R) **U R**

(Ex.) **Part Number** - **A** - **B** - **Color** - **R** - **E, G, S, F**
MPBHB10 - 800 - 600 - S - R20 - E30-G30-S30-F60

Ⓜ The unit price is for 2 notches provided symmetrically on right and left sides.

 **Alterations** **Part Number** - **A** - **B** - **Color** - (CC, MTE, MTF...etc.)
MPBD10 - 250 - 200 - S - CC15

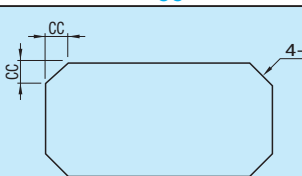
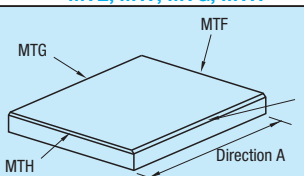
Alterations Code	Four Corner Cuts CC	Edge Chamfering MTE, MTF, MTG, MTH
Spec.	 <p>Cuts 4 corners. 5≤CC≤50 1mm Increment Ordering Code CC25 Ⓜ Applicable to MPBD and PBD</p>	 <p>Chamfers any desired edge. 0.5~1R Ordering Code MTE-MTG Ⓜ Notched portions will not be chamfered.</p>

Load Capacity Guideline
 Supported on two edges of Length B.

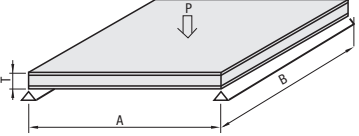

Type	Plate Size			Load Reference	
	T	A	B	N	kgf
Melamine Resin Sandwiched Plywood	10	900	300	127	13
			600	275	28
			750	333	34
		1200	300	59	6
			600	118	12
			300	363	37
Laminated Plywood	15	900	600	745	76
			750	922	94
			300	157	16
		1200	600	304	31
			750	392	40
			300	598	61
20	900	600	1216	124	
		750	1471	150	
		300	245	25	
		1200	600	510	52
			750	647	66
			300	1157	118