

Extrusion End Caps

For 8 Series (Slot Width 10mm) Aluminum Extrusions

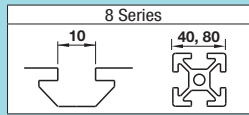

Features: Standard caps for protecting extrusion end faces. Alterations for Aluminum Extrusions are not necessary.

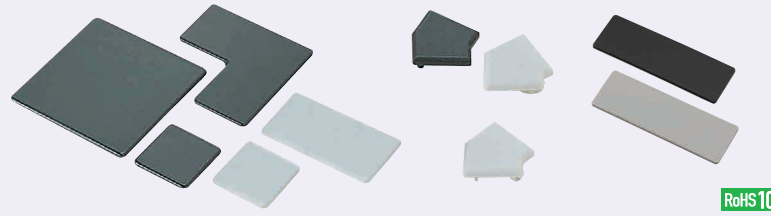

Type	Material
HFC GFC	Polyamide
HFCL	Low Density Polyethylene

- Some products are not required to specify colors. In that case, color is black.
- The pin's shape and numbers of extrusion end caps may be changed to prevent caps from easily falling off.
- HFCL is not applicable to extrusions with Wrench Hole in Fixed Position (P785), D Type Hole (P790), or L Hole (P793).
- Due to the properties of its material, when HFCL is mounted onto the mating Aluminum extrusion, some dim. variation may be generated.

RoHS10

HFC8-4040

HFCL8-4040

HFC8-4080

HFCL8-4080

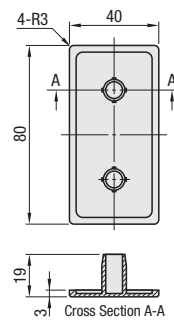
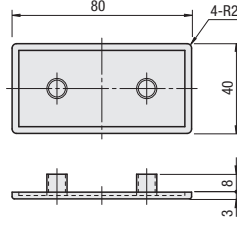
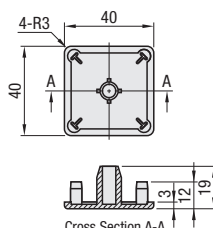
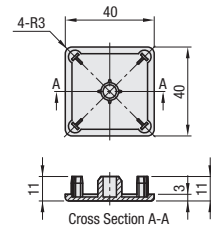

HFC8-40120

HFC8-8080

HFC8-808040

GFC8-4040

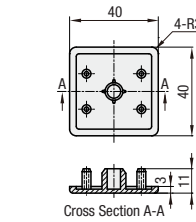
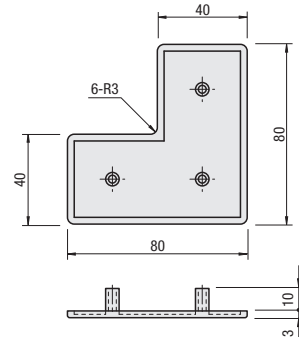
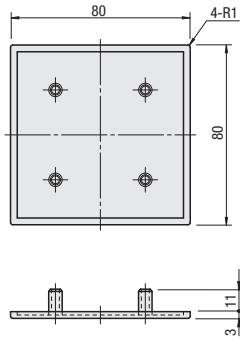
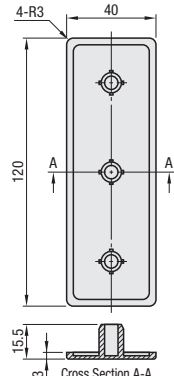

HFC30A8

HFC45A8

HFC60A8

HFCR8-4040

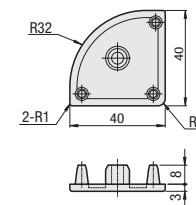
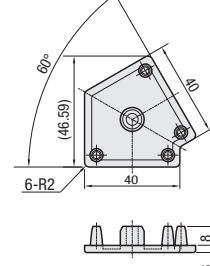
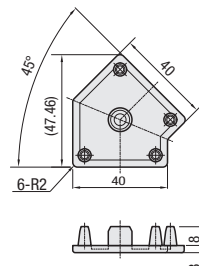
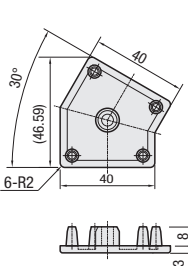

- HFC and HFCL can be used for each Aluminum Extrusion other than GFS/GNFS Series.
- For GFS Series Aluminum Extrusions, select GFC or HFCD (P704).
- Only for GFC, 4 tabs are fitted into the mating extrusion slot upon assembly.

Part Number Type	No.	Color	Unit Price			Applicable Extrusion
			1 - 14 pc(s).	15 - 19	20 - 200	
HFC8	4040	B (Black)				8-4040(1)
	4080					8-4080
	40120					8-40120
	8080					8-8080
	808040					8-808040
HFCL8	4040	S (Light Gray)				8-4040
	4080					8-4080
HFC30A8						30A8-40
HFC45A8						45A8-40
HFC60A8						60A8-40
HFCR8-4040						8-4040
GFC8	4040	B				GFS8-4040(2)

Part Number - Color
HFC30A8 - B

ex

When using Aluminum Extrusion HFS8-80160, please use 2 pieces of HFC8-8080.

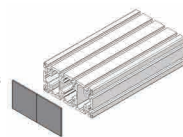

(1) Not applicable to EFSH8-4040. (2) This extrusion end cap can be used for each GFS Series or other type Aluminum Extrusion having the same shape.

Features: Extrusion End Caps for protecting 3 sides at corners.



HFCK8-4040

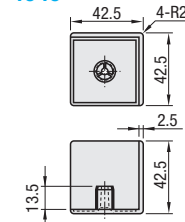

RoHS10

The pin shape and numbers of extrusion caps may be changed to prevent caps from easily falling off. Material: Polyamide

Part Number	Color	Accessory	Applicable Extrusion *	Unit Price	Volume Discount Rate
HFCK8-4040	B (Black)	HFBMB5-15	8-4040	1 - 14 pc(s).	15~19 20~200

* For Aluminum Extrusion EFS Series, the same extrusion end caps as of HFS Series can be used.

Ordering Example Part Number
HFCK8-4040-B

ex

Example

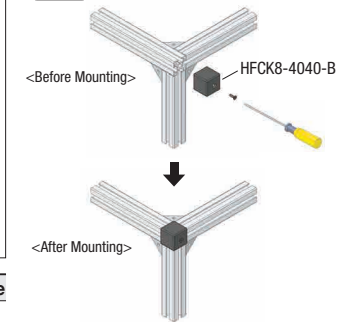

Tapping on extrusion is not required.

Features: Extrusion End Caps Screw Mounting Type. Requires no alteration and excels in safety.



HFCB8-4040 (Screw Fixing Type)

HFCB8-4080 (Screw Fixing Type)

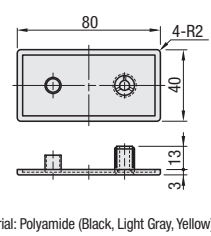
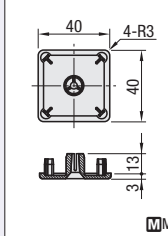

Material: Polyamide (Black, Light Gray, Yellow)

Part Number Type	No.	Color	Unit Price			Applicable Extrusion *
			1 - 14 pc(s).	15 - 19	20 - 500	
HFCB8	4040	B (Black) S (Light Gray) Y (Yellow)				8-4040
	4080	Yellow Type is available for 4040 only.				8-4080

* For Aluminum Extrusion EFS Series, the same extrusion end caps as of HFS Series can be used.
Flat Head Screw is included for Screw Mount Type. (Black: HFBMB5-15, Light Gray, Yellow: SHFBS5-15)

Ordering Example Part Number
HFCB8-4040-S

ex

Example

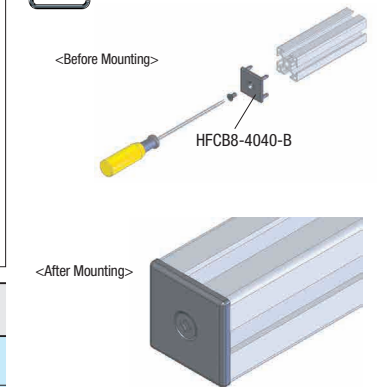

Tapping on extrusion is not required.

Features: Extrusion End Caps only for GFS8-4040 and GFS8-4080. Alterations are required.

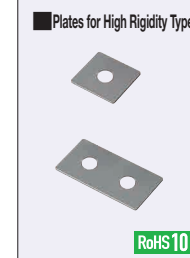

HFCD8-4040

HFCD8-4080

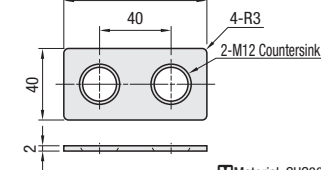
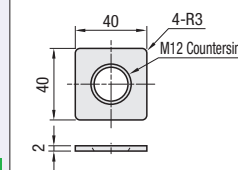

Material: SUS304

Part Number Type	No.	Applicable Screw	Applicable Extrusion	Unit Price	Volume Discount Rate
HFCD8	4040	SHFBS12-20 (Not included)	GFS8-4040	1 ~ 9 pc(s).	10~50
	4080		GFS8-4080		

ex

Ordering Example

Part Number
HFCD8-4040

Special alteration is required on cross sections of extrusions to mount extrusion end caps. (P794)