

LIFTER BLOCKS / SIDE GAUGES / REAR GAUGES / PRELOAD PINS

Lifter block **FLOLB**

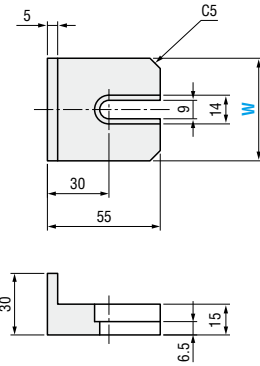

Lifter block **FLOLBA**

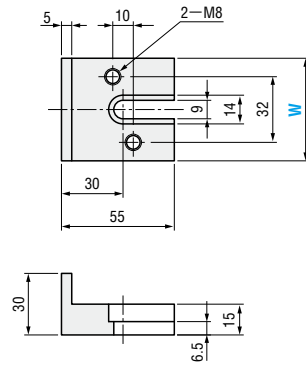

Lifter block **FLOLBB**

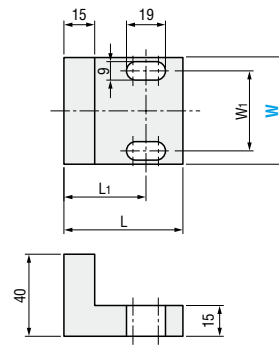

S45C

Side gauge **FLOSG**

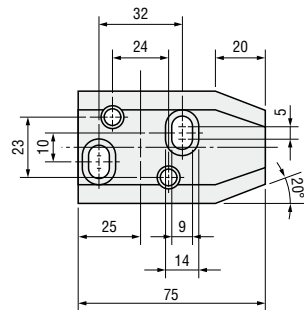
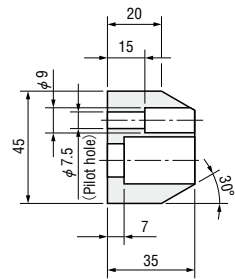

S45C

Rear gauge **FLORG**

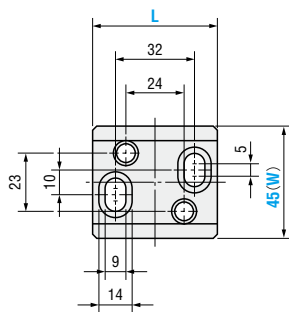
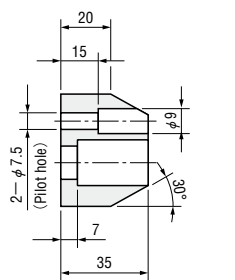

S45C

Preload pin **FLAP**

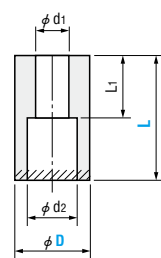

S45C
part is HF induction hardening.

■ Lifter block **FLOLB · FLOLBA · FLOLBB**

FLOLBB dimensions

W	W1	L	L1
52	39	58	40
62	48	64	40
65	55	80	55

Catalog No.	W
FLOLB FLOLBA	45
	50
FLOLBB	60
	52
	62
	75

Order

■ Side gauge **FLOSG**

Order

■ Rear gauge **FLORG**

Catalog No.	W	L
FLORG	45	50
		55

Order -

■ Preload pin **FLAP**

d1	d2	L1	Catalog No.	D	L 10mm increment
9	14	20	FLAP	25	40~60
		40			70~100
13	20	25			50~60
		45			70~100
		65			110~150

Order -

Days to Ship

Price