

Order 订货范例 型式 C-B600ZZ

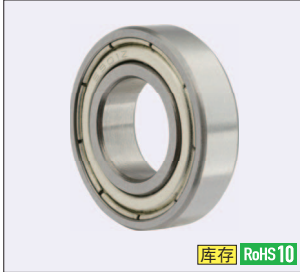

C-B6□□□ZZ

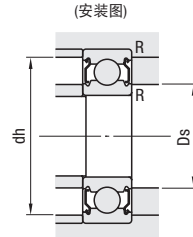
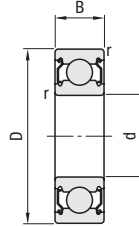

材 质 SUJ2
轴承精度 GB 307 P0
JIS B 1514 0级

型式	d	D	B	r (min)	基本额定负载		容许转速 rpm (参考)	安装尺寸			重量 (g) (参考)	
					Cr (动) N	Cor (静) N		Ds		dh (max)		R (max)
C-B6700ZZ	10	15	4	0.2	600	300	15000	10.4	11.21	14.2	0.2	2
C-B6800ZZ		19	5	0.3	1280	650	34000		12.5	17		5
C-B6900ZZ		22	6		1890	890	32000	12	13	20	9	
C-B6000ZZ		26	8	3190	1370	30000	13.5		24	19		
C-B6200ZZ		30	9	0.6	3570	1670	24000	14	16	26	32	
C-B6300ZZ		35	11	0.2	5740	2450	21000		16.5	31	0.6	52
C-B6701ZZ	12	18	4	0.3	640	370	13000	12.4	13.86	16.7	0.2	3
C-B6801ZZ		21	5		1340	730	32000		14.5	19		6
C-B6901ZZ		24	6	2020	1020	30000	14	15	22	11		
C-B6001ZZ		28	8	3570	1670	27000		16	26	21		
C-B6201ZZ		32	10	0.6	4270	1930	22000	16	17	28	37	
C-B6301ZZ		37	12	1	6790	2940	19000		17	18	32	60
C-B6702ZZ	15	21	4	0.2	660	410	11000	15.4	16.86	19.7	0.2	4
C-B6802ZZ		24	5	1460	880	27000	17		17.5	22		7
C-B6902ZZ		28	7	0.3	2560	1400		26000	17	26	0.3	16
C-B6002ZZ		32	9	3920	1980	23000	19	19		30	30	
C-B6202ZZ		35	11	0.6	5430	2520		19000	19	20	31	45
C-B6302ZZ		42	13	1	7980	3820	17000	20	22.5	37	1	83
C-B6703ZZ	17	23	4	0.2	700	460	9500	17.4	18.86	21.1	0.2	4
C-B6803ZZ		26	5	1560	1020	25000	19		19.5	24		8
C-B6903ZZ		30	7	0.3	3260	1810		23000	19	20	28	18
C-B6003ZZ		35	10	4760	2350	20000	21	21		33	39	
C-B6203ZZ		40	12	0.6	6720	3220		17000	21	23	36	0.6
C-B6303ZZ		47	14	1	9450	4590	15000	22	25.5	42	1	113
C-B6704ZZ	20	27	4	0.2	730	510	8500	20.4	22.36	25.5	0.2	6
C-B6804ZZ		32	7	2800	1730	20000	22		22.5	30		19
C-B6904ZZ		37	9	0.3	4480	2590		19000	24	24	35	0.3
C-B6004ZZ		42	12	0.6	6580	3540	17000	24		26	38	0.6
C-B6204ZZ		47	14	1	8960	4660	14000	25	42	42	1	106
C-B6304ZZ		52	15	1.1	11130	5530	13000	26.5	28	45.5	1	145
C-B6805ZZ	25	37	7	0.3	3010	2070	18000	27	29	35	0.3	22
C-B6905ZZ		42	9		4940	3190	16000			29		40
C-B6005ZZ		47	12	0.6	7070	4100	15000	29	30.5	43	0.6	80
C-B6205ZZ		52	15	1	9800	5500	12000	30	32	47	1	128
C-B6305ZZ		62	17	1.1	14840	7630	11000	31.5	36	55.5	1	235
C-B6806ZZ		42	7	0.3	4538	3402	15000	32	33	40	0.3	27
C-B6906ZZ	47	9	7242	5033	14000	34	45		53			
C-B6006ZZ	55	13	1	9240	5810	12000	35	37	50	1	116	
C-B6206ZZ	62	16		13650	7910	10000		39	57		199	
C-B6306ZZ	72	19	26700	15000	9500	36.5	42.5	65.5	345			
C-B6807ZZ	30	47	7	0.3	4729	3821	13000	37	38	45	0.3	32
C-B6907ZZ		55	10	0.6	10900	7818	12000		39	40		51
C-B6007ZZ		62	14	1	16000	10300	11000	40	42	57	1	151
C-B6207ZZ		72	17	25700	15300	9500	41.5	45	65.5	284		
C-B6307ZZ		80	21	1.5	33500	19200	8500	43	47	72	1.5	464
C-B6808ZZ		52	7	0.3	3570	3080	12000	42	43	50	0.3	33
C-B6908ZZ	62	12	0.6	13678	9968	11000	44	45	58	0.6	132	
C-B6008ZZ	40	68	15	1	16800	11500	10000	45	47	63	1	190
C-B6208ZZ		80	18		29100	17900	8500		46.5	51		73.5
C-B6308ZZ		90	23	1.5	40500	24000	7500	48	53	82	1.5	636
C-B6809ZZ		58	7	0.3	6187	5381	11000	47	47.5	56	0.3	42
C-B6909ZZ		68	12	0.6	14100	10830	9700	49	50	64	0.6	148
C-B6009ZZ		75	16	1	20900	15200	9000	50	53.5	70	1	241
C-B6209ZZ	85	19	31500		20400	7500	51.5	55.5	78.5	420		
C-B6309ZZ	100	25	1.5	53000	32000	6700	53	61.5	92	1.5	829	
C-B6810ZZ	50	65	7	0.3	6610	6090	9600	52	52.5	63	0.3	65
C-B6910ZZ		72	12	0.6	14540	11710	9000		54	55		68
C-B6010ZZ		80	16	1	21800	16600	8500	55	57.5	75	1	261
C-B6210ZZ		90	20		35000	23200	7100		56.5	60		83.5
C-B6310ZZ		110	27	2	62000	38500	6000	59	68	101	2	1060

kgf=N×0.101972



Delivery 交货期



库存品
隔日上海·广州发货 P.9
(17:00前订购的库存品可当日发货。)

请询价 下述2种方法

24h Web报价 FAX报价

请致电: 021-6710-0701

Order 型式 C-SB6006ZZ
订货范例

C-SB6□□□ZZ (安装图)

材质 相当于SUS440C
轴承精度 GB 307 P0
JIS B 1514 0级

CAD 2D 3D 库存 RoHS10

型式	d	D	B	r (min)	基本额定负载		容许转速 rpm (参考)	安装尺寸			重量 (g) (参考)		
					Cr (动) N	Cor (静) N		min	max	R (max)			
C-SB6700ZZ	10	15	4	0.2	480	240	15000	10.4	11.21	14.2	0.2	2	
C-SB6800ZZ		19	5	0.3	1020	470	34000		12.5	17	0.3	5	
C-SB6900ZZ		22	6		1600	710	32000		13	20		9	
C-SB6000ZZ		26	8		2710	1110	30000		13.5	24		19	
C-SB6200ZZ		30	9	3050	1340	24000	16		26	32			
C-SB6300ZZ	35	11	4810	1930	21000	14	16.5	31	0.6	52			
C-SB6701ZZ	12	18	4	0.2	510	290	13000	12.4	13.86	16.7	0.2	3	
C-SB6801ZZ		21	5	1140	580	32000	14.5		19	0.3	6		
C-SB6901ZZ		24	6	1720	830	30000	15		22		11		
C-SB6001ZZ		28	8	3050	1340	27000	16		26		21		
C-SB6201ZZ		32	10	4050	1710	22000	16		17	28	0.6	37	
C-SB6301ZZ	37	12	5770	2350	19000	17	18	32	1	60			
C-SB6702ZZ	15	21	4	0.2	520	320	11000	15.4	16.86	19.7	0.2	4	
C-SB6802ZZ		24	5	1230	700	27000	17.5		22	0.3	7		
C-SB6902ZZ		28	7	2570	1270	26000	19		26		16		
C-SB6002ZZ		32	9	3330	1590	23000	19		30		30		
C-SB6202ZZ		35	11	4550	2070	19000	20		31	45			
C-SB6302ZZ	42	13	6800	3060	17000	20	22.5	37	1	83			
C-SB6703ZZ	17	23	4	0.2	560	360	9500	17.4	18.86	21.1	0.2	4	
C-SB6803ZZ		26	5	1330	810	25000	19.5		24	0.3	8		
C-SB6903ZZ		30	7	2730	1440	23000	20		28		18		
C-SB6003ZZ		35	10	3560	1840	20000	21		33		39		
C-SB6203ZZ		40	12	5690	2700	17000	21		23	36	0.6	66	
C-SB6303ZZ	47	14	8050	3730	15000	22	25.5	42	1	113			
C-SB6704ZZ	20	27	4	0.2	780	400	8500	20.4	22.36	25.5	0.2	6	
C-SB6804ZZ		32	7	2390	1380	20000	22.5		30	0.3	19		
C-SB6904ZZ		37	9	3790	2070	19000	22		35		36		
C-SB6004ZZ		42	12	5590	2870	17000	24		38		69		
C-SB6204ZZ		47	14	7620	3700	14000	25		42	106			
C-SB6304ZZ	52	15	9440	4420	13000	26.5	45.5	1	145				
C-SB6805ZZ	25	37	7	0.3	2560	1650	18000	27	35	0.3	22		
C-SB6905ZZ		42	9	3920	2540	16000	29		40		42		
C-SB6005ZZ		47	12	6010	3280	15000	29		30.5		43	0.6	80
C-SB6205ZZ		52	15	8330	4420	12000	30		32	47	1	128	
C-SB6305ZZ		62	17	11600	6330	11000	31.5		36	55.5	1	235	
C-SB6806ZZ	30	42	7	0.3	4538	3402	15000	32	33	0.3	27		
C-SB6906ZZ		47	9	6340	4400	14000	32		34		45	48	
C-SB6006ZZ		55	13	13200	8300	13000	35		37		50	1	116
C-SB6206ZZ		62	16	11620	6330	10000	35		39	57	1	199	
C-SB6306ZZ		72	19	16700	15000	9500	36.5		42.5	65.5	1	345	
C-SB6807ZZ	35	47	7	0.3	4729	3821	13000	37	38	0.3	32		
C-SB6907ZZ		55	10	10900	7818	12000	39		40		51	0.6	88
C-SB6007ZZ		62	14	16000	10300	11000	40		42		57	1	151
C-SB6207ZZ		72	17	25700	15300	9500	41.5		45	65.5	1	284	
C-SB6307ZZ		80	21	33500	19200	8500	43		47	72	1.5	464	
C-SB6808ZZ	40	52	7	0.3	4923	4178	12000	42	43	0.3	35		
C-SB6908ZZ		62	12	13678	9968	11000	44		45		58	0.6	132
C-SB6008ZZ		68	15	16800	11500	10000	45		47		63	1	190
C-SB6208ZZ		80	18	29100	17900	8500	46.5		51	73.5	1	366	
C-SB6308ZZ		90	23	40500	24000	7500	48		53	82	1.5	636	
C-SB6809ZZ	45	58	7	0.3	6187	5381	11000	47	47.5	0.3	42		
C-SB6909ZZ		68	12	14100	10830	9700	49		50		64	0.6	148
C-SB6009ZZ		75	16	20900	15200	9000	50		53.5		70	1	241
C-SB6209ZZ		85	19	31500	20400	7500	51.5		55.5	78.5	1	420	
C-SB6309ZZ		100	25	53000	32000	6700	53		61.5	92	1.5	829	
C-SB6810ZZ	50	65	7	0.3	6610	6090	9600	52	52.5	0.3	65		
C-SB6910ZZ		72	12	14540	11710	9000	54		55		68	0.6	145
C-SB6010ZZ		80	16	21800	16600	8500	55		57.5		75	1	261
C-SB6210ZZ		90	20	35000	23200	7100	56.5		60	83.5	1	459	
C-SB6310ZZ		110	27	62000	38500	6000	59		68	101	2	1060	

<使用C-VALUE零件时的注意事项>

- 该产品为C-VALUE零件。C-VALUE零件的详细说明请参阅P.721
同一产品的米思米品质产品请参阅左页
- 为专用于轻负载、中·低速旋转、中精度旋转用途的产品。
 - 请在仔细确认C-VALUE零件确认要点①、②的基础上使用。
 - 内部间隙量及额定负载与普通的米思米品质产品不同。
 - 请勿用于高负载、高速旋转、高旋转精度的部位。

此产品材质防锈性能弱于SUS3XX系列不锈钢。请勿直接使用于易腐蚀环境。

kgf=N×0.101972



Delivery
交货期



库存品

隔日上海·广州发货 P.9
(17:00前订购的库存品可当日发货。)

请询价 下述2种方法

24小时 Web报价 FAX报价

图P.13 请致电: 021-6710-9701

13 轴承座组件

轴承座组件
圆型

轴承座组件
方型

轴承

滚珠轴承组件

小轴承用

凸轮轴承随动器

Order 订货范例 **C-B604DDU**

■接触式橡胶密封圈型 **C-B6□□DDU**

CAD 2D 3D 库存 RoHS10

材质 SUJ2
轴承精度 GB 307 P0
JIS B 1514 0级

型式	d	D	B	r (min)	基本额定负载		容许转速 rpm (参考)	安装尺寸			重量 (g) (参考)
					Cr (动) N	Cor (静) N		Ds (min)	dh (max)	R (max)	
C-B693DDU	3	8	4	0.15	558	180	60000	4.2	6.8	0.15	1
C-B623DDU		10			631	219			50000		
C-B684DDU	4	9	4	0.2	641	227	53000	4.6	8.4	0.2	2
C-B694DDU		11			957	350			48000		
C-B604DDU		12	5		1301	488	40000	5.6	10.4	0.2	3
C-B624DDU		13			1340	523	36000		8		13
C-B634DDU	16	5	0.2	716	282	45000	5.8	10.2	0.1	2	
C-B685DDU	11			1077	432	43000		6.6	11.4	0.2	3
C-B695DDU	5	14	5	0.3	1329	507	40000		7	12.4	0.3
C-B605DDU		16			1729	675	36000	7.4		14	
C-B625DDU	6	19	6	0.2	2336	896	32000	7.4	16.6	0.3	8
C-B635DDU		13			1082	442			40000		
C-B686DDU	6	15	5	0.2	1340	523	38000	7.6		13.4	0.3
C-B696DDU		17			2263	846			8	15	
C-B606DDU	6	19	6	0.3	2336	896	32000	8	17	0.3	8
C-B626DDU		22			3333	1423	30000		10.5		
C-B636DDU	7	14	5	0.2	1173	513	40000	7.8	13.2	0.2	4
C-B687DDU		17			1605	719	36000		9		
C-B697DDU	7	19	6	0.2	2336	896		36000		9	17
C-B607DDU		22			3287	1379	30000		9.4		19.6
C-B627DDU	8	16	5	0.3	1252	592	36000	9.4		14.6	0.2
C-B688DDU		19			2237	917			34000	10	
C-B698DDU	8	22	7	0.3	3293	1379	28000	10			20
C-B608DDU		24			3333	1423			28000	12	22
C-B628DDU	8	28	9	0.3	4563	1983	28000	12			23
C-B638DDU		17			1327	668			36000	10.4	15.6
C-B689DDU	9	20	6	0.3	2467	1081	34000	11	18		0.3
C-B699DDU		24			3356	1444			32000	11	
C-B609DDU	9	26	8	0.3	4575	1983	28000	11.4	23.6		0.3
C-B629DDU											

kgf = N × 0.101972

- ベアリングホルダセット 丸型
- ベアリングホルダセット 角型
- ベアリング
- 玉軸受ユニット
- ベアリング用小物
- カムフッテアロー



Delivery 交货期



库存品
隔日上海・广州发货 P.9
(17:00前订购的库存品可当日发货。)

请询价 下述2种方法

24小时在线 Web报价 FAX报价

P.13 请致电: 021-6710-8701



深溝玉軸受 一接触ゴムシール形—
深沟滚珠轴承
 —接触式橡胶密封圈型—



CAD数据文件夹名: 13_Bearings_with_Holder

Order 订货范例 **型式**
C-B600DDU



接触式橡胶密封圈型
C-B6□□□DDU

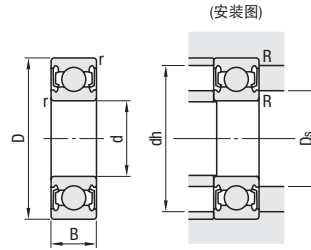

材质 SUJ2
 轴承精度 GB 307 P0
 JIS B 1514 0级

*密封圈为NBR(丁腈橡胶)。

型式	d	D	B	r (min)	基本额定负载		容许转速 rpm (参考)	安装尺寸				重量 (g) (参考)
					Cr (动) N	Cor (静) N		Ds		dh (max)	R (max)	
								(min)	(max)			
C-B680DDU	10	19	5	0.3	1716	840	37000	12	12	17	0.3	6
C-B690DDU		22	6		2695	1273			20	10		
C-B600DDU		26	8	4550	1970	24		18				
C-B620DDU		30	9	5100	2390	26		32				
C-B630DDU	12	35	11	0.6	8100	3450	22000	14	16.5	31	0.6	52
C-B6801DDU		21	5		1915	1041			19	7		
C-B6901DDU		24	6	2886	1466	22		10				
C-B6001DDU		28	8	5100	2370	26		22				
C-B6201DDU	15	32	10	0.6	6800	3050	22000	16	17	28	0.6	37
C-B6301DDU		37	12		9700	4200			32	60		
C-B6802DDU		24	5	2073	1253	22		9				
C-B6902DDU		28	7	4321	2259	26		15				
C-B6002DDU	17	32	9	0.3	5600	2830	24000	17	19	30	0.3	31
C-B6202DDU		35	11		7650	3750			31	45		
C-B6302DDU		42	13	11400	5450	37		83				
C-B6803DDU		26	5	2233	1456	24		9				
C-B6903DDU	20	30	7	0.3	4588	2565	23000	19	19.5	28	0.3	10
C-B6003DDU		35	10		6000	3250			33	41		
C-B6203DDU		40	12	9550	4800	36		67				
C-B6303DDU		47	14	13600	6650	42		113				
C-B6804DDU	25	32	7	0.6	4015	2462	21000	22	22	30	0.6	18
C-B6904DDU		37	9		6381	3682			35	40		
C-B6004DDU		42	12	9400	5000	38		68				
C-B6204DDU		47	14	12800	6600	42		107				
C-B6304DDU	30	52	15	1	15900	7900	14000	26.5	28	45.5	1	145
C-B6805DDU		37	7		4303	2932			35	24		
C-B6905DDU		42	9	7001	4540	40		47				
C-B6005DDU		47	12	10100	5850	43		79				
C-B6205DDU	35	52	15	0.6	14000	7850	13000	29	30	43	0.6	129
C-B6305DDU		62	17		20600	11200			47	235		
C-B6806DDU		42	7	4538	3402	40		27				
C-B6906DDU		47	9	7242	5003	45		53				
C-B6006DDU	40	55	13	0.3	13200	8300	13000	32	36.5	50	0.3	116
C-B6206DDU		62	16		19500	11300			57	199		
C-B6306DDU		72	19	26700	15000	65		345				
C-B6807DDU		47	7	4729	3821	45		32				
C-B6907DDU	45	55	10	0.6	10900	7818	12000	37	38	45	0.6	88
C-B6007DDU		62	14		16000	10300			57	151		
C-B6207DDU		72	17	25700	15300	65.5		284				
C-B6307DDU		80	21	33500	19200	72		464				
C-B6808DDU	50	52	7	0.3	4923	4178	12000	42	43	50	0.3	35
C-B6908DDU		62	12		13678	9968			58	132		
C-B6008DDU		68	15	16800	11500	63		190				
C-B6208DDU		80	18	29100	17900	73.5		366				
C-B6308DDU	55	90	23	1.5	40500	24000	7500	46.5	50.5	70	1	636
C-B6809DDU		58	7		6187	5381			81	42		
C-B6909DDU		68	12	14100	10830	86		148				
C-B6009DDU		75	16	20900	15200	90		241				
C-B6209DDU	60	85	19	1	31500	20400	7500	51.5	55.5	78.5	1	420
C-B6309DDU		100	25		53000	32000			91	829		
C-B6810DDU		65	7	6610	6090	83		65				
C-B6910DDU		72	12	14540	11710	88		145				
C-B6010DDU	65	80	16	0.6	21800	16600	8500	55	58.5	75	1	261
C-B6210DDU		90	20		35000	23200			83.5	459		
C-B6310DDU		110	27	62000	38500	99		1060				

kgf=N×0.101972

- 13 轴承座组件
- 轴承座组件
- 轴承座组件
- 轴承
- 滚珠轴承组件
- 小零件 轴承用
- 滚珠轴承随动器



Delivery 交货期



库存品
 隔日上海·广州发货 P.9
 (17:00前订购的库存品可当日发货。)

询价 下述2种方法

24小时 Web询价 FAX询价

请致电: 021-6710-0701

Order 型式 C-B6000
订货范例

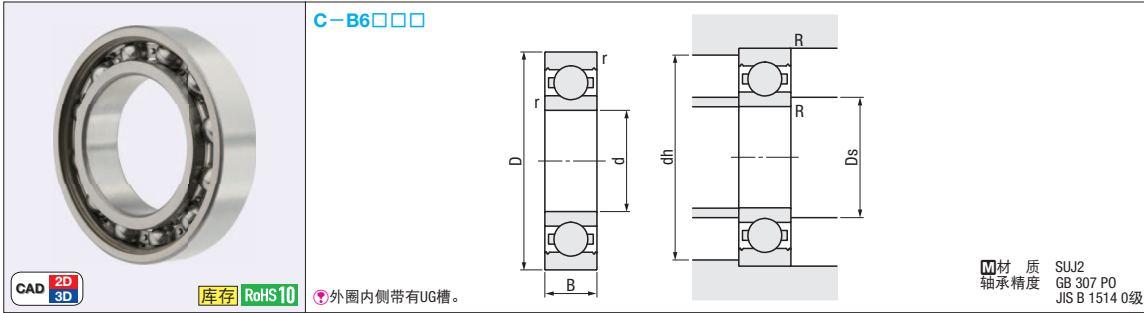

型式	d	D	B	r (min)	基本额定负载		容许转速 rpm (参考)	安装尺寸				重量 (g) (参考)	
					Cr (动) N	Cor (静) N		Ds		dh (max)	R (max)		
C-B6800	10	19	5	0.3	1716	840	37000	12	12.5	17	0.3	6	
C-B6900		22	6		2695	1273			34000	13		20	10
C-B6000		26	8		4550	1970			30000	13.5		24	18
C-B6200	10	30	9	0.6	5100	2390	24000	14	16	26	0.6	32	
C-B6701		18	4	0.2	926	530	13000	12.4	13.86	16.7	0.2	4	
C-B6801		21	5	1915	1041	33000	14.5	19	7				
C-B6901	12	24	6	0.3	2886	1466	31000	14	15	22	0.3	10	
C-B6001		28	8	5100	2370	28000	16	26	22				
C-B6201		32	10	6800	3050	22000	16	17	28	0.6	37		
C-B6702	12	21	4	0.2	937	582	11000	15.4	16.86	19.7	0.2	4	
C-B6802		24	5	2073	1253	28000	17	22	9				
C-B6902		28	7	4321	2259	26000	17	26	15				
C-B6002	15	32	9	0.3	5600	2830	24000	19	19	30	0.3	31	
C-B6202		35	11	7650	3750	20000	19	20	31	0.6		45	
C-B6703		23	4	1000	658	9500	18	18.5	22	5			
C-B6803	17	26	5	0.3	2233	1456	26000	19	19.5	24	0.3	9	
C-B6903		30	7	4588	2565	23000	19	20	28	10			
C-B6003		35	10	6000	3250	22000	19	21	33	41			
C-B6203	17	40	12	0.6	9550	4800	17000	21	23	36	0.6	67	
C-B6704		27	4	1402	729	8500	20.4	22.36	25.5	6			
C-B6804		32	7	4015	2462	21000	22	22.5	30	18			
C-B6904	20	37	9	0.3	6381	3682	19000	22	24	35	0.3	40	
C-B6004		42	12	9400	5000	18000	24	26	38	0.6		68	
C-B6204		47	14	12800	6600	15000	25	28	42	1		107	
C-B6705	20	32	4	0.3	1091	838	7000	26	27	31	0.3	8	
C-B6805		37	7	4303	2932	18000	26	28	35	24			
C-B6905		42	9	7001	4540	16000	27	29	40	47			
C-B6005	25	47	12	0.6	10100	5850	15000	29	30.5	43	0.6	79	
C-B6205		52	15	14000	7850	13000	30	32	47	1	129		
C-B6706		37	4	1143	947	5500	31	32	35.5	9			
C-B6806	30	42	7	0.3	4538	3402	15000	32	33	40	0.3	27	
C-B6906		47	9	7242	5003	14000	32	34	45	53			
C-B6006		55	13	13200	8300	13000	35	37	50	1		116	
C-B6206	30	62	16	1	19500	11300	11000	35	39	57	1	199	
C-B6707		44	5	1866	1635	4900	37	38	42	15			
C-B6807		47	7	4729	3821	13000	37	45	45	0.3	32		
C-B6907	35	55	10	0.6	10900	7818	12000	39	40	51	0.6	88	
C-B6007		62	14	16000	10300	11000	40	42	57	1	151		
C-B6207		72	17	25700	15300	9500	41.5	45	65.6	1	284		
C-B6708	35	50	6	0.3	2516	2233	4300	42	43	48	0.3	23	
C-B6808		52	7	4923	4178	12000	42	43	50	35			
C-B6908		62	12	13678	9968	11000	44	45	58	0.6		132	
C-B6008	40	68	15	1	16800	11500	10000	45	47	63	1	190	
C-B6208		80	18	29100	17900	8500	46.5	51	73.5	1	366		
C-B6709		55	6	2580	2397	3900	47	48	53	0.3	25		
C-B6809	40	58	7	6187	5381	11000	47	47.5	56	42			
C-B6909		68	12	14100	10830	9700	49	50	64	0.6	148		
C-B6009		75	16	20900	15200	9000	50.8	52	69.2	1	241		
C-B6209	45	85	19	1.1	31500	20400	7500	52	54	78	1.1	420	
C-B6810		65	7	6610	6090	9600	52	52.5	63	0.3	65		
C-B6910		72	12	14540	11710	9000	54	55	68	0.6	145		
C-B6010	50	80	16	1	21800	16600	8500	55	57.5	75	1	261	
C-B6210		90	20	35000	23200	7100	56.5	60	83.5	1	459		

kgf=N×0.101972

13
ベアリングホルダセット
(ベアリング)

ベアリングホルダセット
丸型

ベアリングホルダセット
角型

ベアリング

玉軸受ユニット

ベアリング小物

カムフォロア

Delivery 交货期

库存品

隔日上海・广州发货 P.9
(17:00前订购的库存品可当日发货。)

询价 下述2种方法
24小时 Web报价 FAX报价
P.13 请致电: 021-6710-0701

Order 订货范例 C-B6000ZZC3

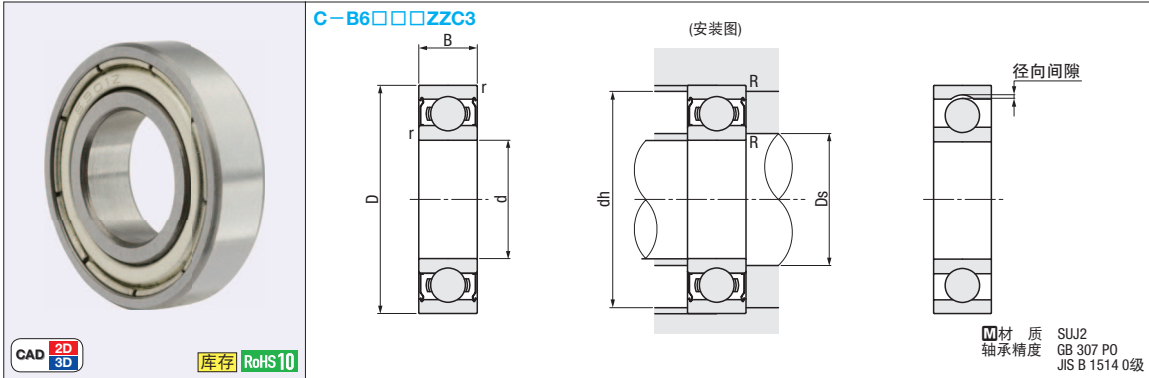

型式	d	D	B	r (min)	基本额定负载		容许转速 rpm (参考)	安装尺寸			重量 (g) (参考)	
					Cr (动) N	Cor (静) N		Ds		R (max)		
								(min)	(max)	dh (max)		
C-B6000ZZC3	10	26	8	0.3	4550	1970	30000	12	13	24	0.3	18
C-B6200ZZC3		30	9	0.6	5100	2390	24000	14	16	26	0.6	32
C-B6300ZZC3		35	11		8100	3450	22000		16.5	31		52
C-B6001ZZC3	12	28	8	0.3	5100	2370	28000	16	15.5	26	0.3	22
C-B6201ZZC3		32	10	0.6	6800	3050	22000		17	18	32	1
C-B6301ZZC3		37	12	1	9700	4200	20000	19	19	30	0.3	31
C-B6002ZZC3	15	32	9	0.3	5600	2830	24000	19	20.5	31	0.6	45
C-B6202ZZC3		35	11	0.6	7650	3750	20000		20	22.5	37	1
C-B6302ZZC3		42	13	1	11400	5450	17000	19	21.5	33	0.3	41
C-B6003ZZC3	17	35	10	0.3	6000	3250	22000	21	23.5	36	0.6	67
C-B6203ZZC3		40	12	0.6	9550	4800	17000		22	25.5	42	1
C-B6303ZZC3		47	14	1	13600	6650	15000	24	38	48	0.6	68
C-B6004ZZC3	20	42	12	0.6	9400	5000	18000	25	26.5	42	1	107
C-B6204ZZC3		47	14	1	12800	6600	15000		26.5	28		45.5
C-B6304ZZC3		52	15	1.1	15900	7900	14000	29	30	43	0.6	79
C-B6005ZZC3	25	47	12	0.6	10100	5850	15000	30	32	47	1	129
C-B6205ZZC3		52	15	1	14000	7850	13000		31.5	36		55.5
C-B6305ZZC3		62	17	1.1	20600	11200	11000	35	36.5	50	116	
C-B6006ZZC3	30	55	13	1	13200	8300	13000	40	41.5	57	1.5	199
C-B6206ZZC3		62	16		19500	11300	11000		38.5	57		345
C-B6306ZZC3		72	19	1.1	26700	15000	9500	41.5	44.5	65.5	284	
C-B6007ZZC3	35	62	14	1	16000	10300	11000	43	47	72	1.5	464
C-B6207ZZC3		72	17	1.1	25700	15300	9500		45	47.5		63
C-B6307ZZC3		80	21	1.5	33500	19200	8500	46.5	50.5	73.5	366	
C-B6008ZZC3	40	68	15	1	16800	11500	10000	48	53	82	1.5	636
C-B6208ZZC3		80	18	1.1	29100	17900	8500		50	53.5		70
C-B6308ZZC3		90	23	1.5	40500	24000	7500	51.5	55.5	78.5	420	
C-B6009ZZC3	45	75	16	1	20900	15200	9000	53	61.5	92	1.5	829
C-B6209ZZC3		85	19	1.1	31500	20400	7500		55	58.5		75
C-B6309ZZC3		100	25	1.5	53000	32000	6700	56.5	60	83.5	459	
C-B6010ZZC3	50	80	16	1	21800	16600	8500	59	68	101	2	1060
C-B6210ZZC3		90	20	1.1	35000	23200	7100					
C-B6310ZZC3		110	27	2	62000	38500	6000					

kgf = N × 0.101972

- 13 轴承座组件
- 轴承座组件 圆型
- 轴承座组件 方型
- 轴承
- 滚珠轴承组件
- 小零件 轴承用
- 凸輪軸承隨動器



Delivery 交货期



库存品
 隔日上海·广州发货 P.9
 (17:00前订购的库存品可当日发货。)

请询价 下述2种方法

24小时在线 Web报价 FAX报价

P.13 请致电: 021-6710-8701

Order 订货范例 **型式**
C-B7204B
C-B7205DDU

■向心球軸承
 -単列・两列组合(普通級)型-

种类	Type	材质
接触角为: 40度	C-B□□□□B	SUJ2
接触角为: 40度 双侧接触式橡胶密封圈	C-B□□□□DDU	SUJ2

CAD 2D/3D 库存 RoHS10

型式	d	D	B	r (min)	基本额定负载		容许转速 rpm (参考)	作用点 a	安装尺寸			重量 (g) (参考)
					Cr (动) N	Cor (静) N			Ds (min)	dh (max)	R (max)	
C-B7200B C-B7200DDU	10	30	9	0.6	6350	2720	11900	12.9	15	25	0.6	30
C-B7201B C-B7201DDU	12	32	10		8050	3740	17500	14.2	17	27		
C-B7202B C-B7202DDU	15	35	11		8700	4360	16000	16.0	20	30		
C-B7203B C-B7203DDU	17	40	12		10700	5550	14200	18.0	22	35		
C-B7204B C-B7204DDU	20	47	14	1	15400	8200	12400	21.1	26	41	1	100
C-B7205B C-B7205DDU	25	52	15		16400	9350	11000	23.7	31	46		120
C-B7206B C-B7206DDU	30	62	16		23400	14300	9400	27.3	36	56		190
C-B7207B C-B7207DDU	35	72	17		30300	19100	8200	30.9	42	65		260
C-B7208B C-B7208DDU	40	80	18		35500	23000	7300	34.2	47	73		350
C-B7209B C-B7209DDU	45	85	19		37200	25400	6800	36.8	52	78		400
C-B7210B C-B7210DDU	50	90	20		38800	27800	6300	39.4	57	83		440

kgf = N × 0.101972

13
 ベアリングホルダセット
 (ベアリング)

- ベアリングホルダセット
- ベアリング角型
- ベアリング
- 玉軸受ユニット
- ベアリング小物
- カムフロッパ



Delivery 交货期



库存品
 隔日上海・广州发货 P.9
 (17:00前订购的库存品可当日发货。)

询价 下述2种方法

24小时在线 Web报价 FAX报价

P.13 请致电: 021-6710-8701

Order 订货范例 **型式**
C-B1204



CAD 2D 3D

库存 RoHS 10

C-B□□□□TN (安装图)

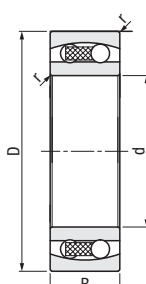

C-B□□□□
C-SB12□□ (安装图)

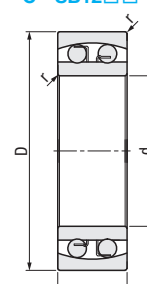

C-B□□□□DDU
C-SB21□□DDU (安装图)

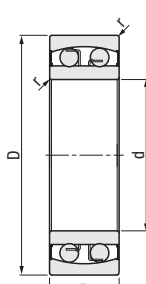

C-SB22□□ (带UG槽) (安装图)

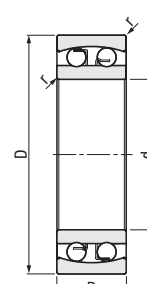

Ⓢ外圈内侧带有UG槽。

种类	Type	材质	型式				d	D	B	r (min)	基本额定负载		容许转数 rpm (参考)	安装尺寸			重量 (g) (参考)
			C-B□□□□	C-SB□□□□	C-B□□□□DDU	C-SB□□□□DDU					Cr (动) N	Cor (静) N		Ds (min)	dh (max)	R (max)	
开放式	C-B□□□□	SUJ2	C-B1200	C-B1200TN	C-SB1200	C-SB1200	10	30	9	0.6	4050	1290	22000	14	25.8	0.6	34
	C-SB□□□□	相当于SUS440C	C-B2200	C-B2200TN	C-SB2200	C-SB2200DDU	12	32	10		5300	1530					
尼龙保持架 双侧接触式橡胶 密封圈	C-B□□□□DDU	SUJ2	C-B1201	C-B1201TN	C-SB1201	C-SB1201	12	32	10		6000	1960	20000	16	27.8	0.6	53
	C-B□□□□DDU	SUJ2	C-B2201	C-B2201TN	C-SB2201	C-SB2201DDU	14	34	11		5600	1960					
尼龙保持架 开放式 双侧接触式橡胶 密封圈	C-B□□□□TN	SUJ2	C-B1202	C-B1202TN	C-SB1202	C-SB1202	15	35	14		6000	2190	18000	19	30.8	0.6	60
	C-SB□□□□DDU	相当于SUS440C	C-B2202	C-B2202TN	C-SB2202	C-SB2202DDU	17	40	12		5900	2300					
尼龙保持架 开放式 双侧接触式橡胶 密封圈	C-B□□□□DDU	相当于SUS440C	C-B1203	C-B1203TN	C-SB1203	C-SB1203	17	40	12		7900	2800	16000	21	35.8	0.6	88
	C-SB□□□□DDU	相当于SUS440C	C-B2203	C-B2203TN	C-SB2203	C-SB2203DDU	20	47	14		7500	2950					
尼龙保持架 开放式 双侧接触式橡胶 密封圈	C-B□□□□DDU	相当于SUS440C	C-B1204	C-B1204TN	C-SB1204	C-SB1204	20	47	14		9800	3950	13000	25	41.4	0.6	140
	C-SB□□□□DDU	相当于SUS440C	C-B2204	C-B2204TN	C-SB2204	C-SB2204DDU	25	52	15		9150	3900					
尼龙保持架 开放式 双侧接触式橡胶 密封圈	C-B□□□□DDU	相当于SUS440C	C-B2205	C-B2205TN	C-SB2205	C-SB2205DDU	25	52	18	9800	4350	10000	35	56.4	1	220	
	C-SB□□□□DDU	相当于SUS440C	C-B1206	C-B1206TN	C-SB1206	C-SB1206	30	62	16	11000	5500						7500
尼龙保持架 开放式 双侧接触式橡胶 密封圈	C-B□□□□DDU	相当于SUS440C	C-B2206	C-B2206TN	C-SB2206	C-SB2206DDU	30	62	16	12200	6800	9000	35	56.4	1	260	
	C-SB□□□□DDU	相当于SUS440C	C-B1207	C-B1207TN	C-SB1207	C-SB1207	35	72	20	18000	6500						7500
尼龙保持架 开放式 双侧接触式橡胶 密封圈	C-B□□□□DDU	相当于SUS440C	C-B2207	C-B2207TN	C-SB2207	C-SB2207DDU	35	72	23	17100	8400	8500	42	65	1	405	
	C-SB□□□□DDU	相当于SUS440C	C-B1208	C-B1208TN	C-SB1208	C-SB1208	40	80	18	19000	7000						7500
尼龙保持架 开放式 双侧接触式橡胶 密封圈	C-B□□□□DDU	相当于SUS440C	C-B2208	C-B2208TN	C-SB2208	C-SB2208DDU	40	80	23	17700	9650	7500	47	73	1	505	
	C-SB□□□□DDU	相当于SUS440C	C-B1209	C-B1209TN	C-SB1209	C-SB1209	45	85	19	22000	10000						7500
尼龙保持架 开放式 双侧接触式橡胶 密封圈	C-B□□□□DDU	相当于SUS440C	C-B2209	C-B2209TN	C-SB2209	C-SB2209DDU	45	85	23	18400	10900	7100	52	78	1	545	
	C-SB□□□□DDU	相当于SUS440C	C-B1210	C-B1210TN	C-SB1210	C-SB1210	50	90	20	27000	10500						7000
尼龙保持架 开放式 双侧接触式橡胶 密封圈	C-B□□□□DDU	相当于SUS440C	C-B2210	C-B2210TN	C-SB2210	C-SB2210DDU	50	90	23	18400	11500	6300	57	83	1	590	
	C-SB□□□□DDU	相当于SUS440C															

Ⓢkgf=N×0.101972

13 轴承座组件

轴承座组件
轴承座组件
轴承
滚珠轴承组件
小零件
凸缘轴承随动器
滚珠轴承随动器



Delivery 交货期

库存品

隔日上海·广州发货 P.9
(17:00前订购的库存品可当日发货。)

询价 下述2种方法

24小时 Web报价 FAX报价

Web P.13 请致电: 021-6710-9701



Order 订货范例

型式
C-B51100
C-BA0414TN

■单向推力球轴承



库存 RoHS10

C-B511□□
C-B512□□

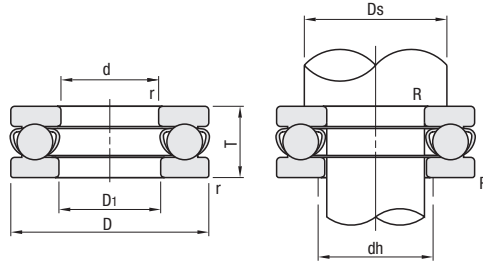

材料 SUJ2
轴承精度 GB 307 P0
JIS B 1514 0级

型式	d	D	T	r (min)	基本额定负载		容许转速 rpm (参考)	安装尺寸			重量 (g) (参考)
					Cr (动) N	Cor (静) N		Ds (min)	dh (max)	R (max)	
C-B51100	10	24	9	0.3	8710	8800	7500	18	16	0.3	20
C-B51200		26	11	0.6	12700	17000	6000			0.6	29
C-B51101	12	28	9	0.3	9035	10000	7000	22	20	0.3	22
C-B51201			11	0.6	13200	19000	6000			0.6	32
C-B51102	15	32	9	0.3	9360	11200	6300	25	22	0.3	24
C-B51202			12	0.6	16600	25000	5000			0.6	43
C-B51103	17	30	9	0.3	9750	12200	6300	28	24	0.3	28
C-B51203			12	0.6	17300	27500	5000			0.6	50
C-B51104	20	40	10	0.3	12740	16600	5600	32	28	0.3	40
C-B51204			14	0.6	19890	25000	4300			0.6	82
C-B51105	25	42	11	0.6	15860	22800	4800	35	32	0.6	59
C-B51205			15		25090	34000	3800				38
C-B51106	30	47	11	0.6	16770	26500	4500	40	37	0.6	68
C-B51206			16		25480	37500	3600				43

kgf=N×0.101972

13
ベアリングホルダセット
(ベアリング)

ベアリング
ホルダセット
丸型

ベアリング
ホルダセット
角型

ベアリング

玉軸受ユニット

ベアリング
小物

カムフォロア
ローラーフォロア

■止推滚针轴承



库存 RoHS10

C-BA□□□□
C-BA□□□□TN

带保持器止推滚针

止推圈

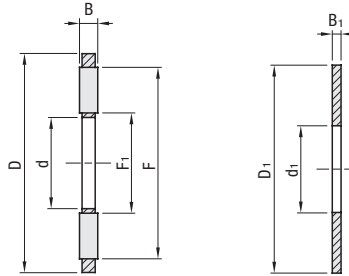

* 止推圈在交货时会有一些变形，以同心圆的方式施加最低200N轴向负载即可使之平整。

材料 SUJ2
轴承精度 GB 307 P0
JIS B 1514 0级

型式	带保持器止推滚针				止推圈×2				容许转速 rpm (参考)	基本动态 额定负载 Ca N	基本静态 额定负载 Coa N	重量 (g) (参考)						
	d	容差	D	容差	B	容差	F	F1					d1	容差	D1	容差	B1	容差
C-BA0414TN	4		14	-0.095	2	0	13	5	4	+0.200 +0.020	14	-0.032	1	+0.05 -0.05	5200	4100	8000	2.7
C-BA0515TN	5	+0.140	15	-0.365			14	6	5		14	-0.302			18540	4275	8280	2.8
C-BA0619	6	+0.020	19				18	7	6		19				17010	6120	13950	5
C-BA0821	8	+0.175	21				20	9	8		21	+0.245			16020	7020	17460	8
C-BA1024	10	+0.025	24	-0.11			23	12	10		24	+0.025			15210	8280	22950	9
C-BA1226	12	+0.212	26	-0.44			25	14	12		26	-0.370			13680	8910	26100	
C-BA1528	15	+0.032	28				27	17	15		28				11880	10170	32400	12
C-BA1730	17		30				29	19	17		30				10890	10710	35550	14
C-BA2035	20	+0.250	35	-0.12 -0.51			34	22	20		35	+0.370 -0.050			9450	11790	41850	19
C-BA2542	25	+0.004	42	-0.13			41	29	25		42	+0.040 -0.440			7560	13230	52200	23
C-BA3047	30		47	-0.52			46	34	30		47				6390	14670	63000	26

* 带“TN”型号，保持架为尼龙保持架。

kgf=N×0.101972



Delivery 交货期



库存品
隔日上海·广州发货 P.9
(17:00前订购的库存品可当日发货。)

请询价 下述2种方法

24小时 Web报价 FAX报价

※ P.13 请致电: 021-6710-0701